



LIMITEX AG

HAZARDOUS AREAS

Rotary limit switch

Explosion proof rotary limit switch.
 Rugged and reliable, Limitex AG is used to control the movement of industrial machinery in potentially explosive areas.

FEATURES

- It consists of a gear motor that transfers movement through a primary input reduction stage (worm gear and helical toothed gear) and one or more secondary output stages (pairs of straight toothed gears).
- Accurate adjustment of cams by means of screws.
- Positive opening NC contacts for safety functions.
- Mechanical life of switches: 1 million operations.
- IP protection degree: Limitex AG is classified IP66.
- Extreme temperature resistance: -40°C to +60°C.
- It features rugged external enclosure made of G20 cast iron, stainless steel transmission and gear driving shafts, self-lubricating technopolymer gears and driving bushes.
- All materials and components used are wear resistant and guarantee protection of the unit against water and dust.

OPTIONS

- Revolution ratios from 1:15 to 1:499, achieved by combining different secondary output stages.
- Snap action switches with 1NO+1NC change-over contacts.
- It can be equipped with a cam set with 2-3-4 switches.
- Available with flange for direct coupling to the motor.
- Available with direct control switches to enable direct action on the motor.

CERTIFICATIONS

- CE marking.
- Atex certification EN 60079-0:2009, EN 60079-1:2007, EN 60079-31:2009.
- Conformity to Standards IECEx IEC 60079-0:2011, IEC 60079-1:2007-04 and IEC 60079-31:2008.

Fill in the request form to configure properly the product.

CERTIFICATIONS

Conformity to Atex Standards	EN 60079-0:2009 Explosive atmospheres - Equipment - General requirements
	EN 60079-1:2007 Explosive atmospheres - Equipment protection by flameproof enclosures "d"
	EN 60079-31:2009 Explosive atmospheres - Equipment dust ignition protection by enclosure "t"
Conformity to IECEx Standards	IEC 60079-0:2011 Explosive atmospheres - Equipment - General requirements
	IEC 60079-1:2007-04 Explosive atmospheres - Equipment protection by flameproof enclosures "d"
	IEC 60079-31:2008: Explosive atmospheres - Equipment dust ignition protection by enclosure "t"
Atex Certification	INERIS 13ATEX0020X
IECEX Certification	IECEX INE 13.0051X
Certification for group I, IIA, IIB and IIC with the marks*	MINING: I M2 Ex d I Mb (ATEX) Ex d I Mb (IECEX)
	GAS Zone 1 and 2: II2G Ex d IIB T6 Gb or Ex d IIC T6 Gb (ATEX) Ex d IIB T6 or Ex d IIC T6 Gb (IECEX)
	DUST Zone 21 and 22: II2D Ex tb IIIC T85°C Db IP66 (ATEX) Ex tb IIC T85°C Db IP66 (IECEX)
	GAS & DUST: II2GD Ex d IIB or IIC T6 Gb Ex tb IIC T85°C Db IP66
Conformity to Community Directives	2014/35/UE Low Voltage Directive
	2006/42/CE Machinery Directive
Conformity to CE Standards	EN 60204-1 Safety of machinery - Electrical equipment of machines
	EN 60204-32 Safety of machinery - Electrical equipment of machines - Requirements for hoisting machines
	EN 60947-1 Low-voltage switchgear and controlgear
	EN 60947-5-1 Low-voltage switchgear and controlgear - Control circuit devices and switching elements - Electromechanical control circuit devices
	EN 60529 Degrees of protection provided by enclosures
Markings and homologations	CE  IEC IECEX

GENERAL SAFETY SPECIFICATIONS



Maximum power supply	300 Vac
Maximum current intensity	3 A
Maximum dissipated power	2 Watt
Rated frequency	50 / 60 Hz

GENERAL TECHNICAL SPECIFICATIONS

Operational ambient temperature	-40°C/+60°C
Protection degree	IP 66
Maximum rotation speed	800 rev./min.
Cable entry	Nr. 2 M20x1,5
	Nr. 2 M25x1,5
	Nr. 2 ½ NPT

* The user is responsible for choosing the proper limit switch protection type, group and maximum case temperature. The user is also responsible for the correct installation, connection to the electrical network and use and maintenance of the electrical devices.

TECHNICAL SPECIFICATIONS OF THE MICROSWITCHES

Code	PRSL0003XX	PRSL0011XX
Utilisation category	AC 15	
Rated operational voltage	250 Vac	
Rated operational current	3 A	
Rated thermal current	10 A	
Rated insulation voltage	300 Vac	
Mechanical life	1x10 ⁶ operations	
Connections	6.3 mm Faston taps	Screw-type terminals
Wires	-	2x0.5mm ² , 2x1.5 mm ² , 1x2.5 mm ²
Tightening torque	-	0.5 Nm
Microswitch type	Single break, snap action	
Contacts	1NO+1NC change-over contacts (All NC contacts are of the positive opening operation type )	
Scheme		

OVERALL DIMENSIONS (mm)

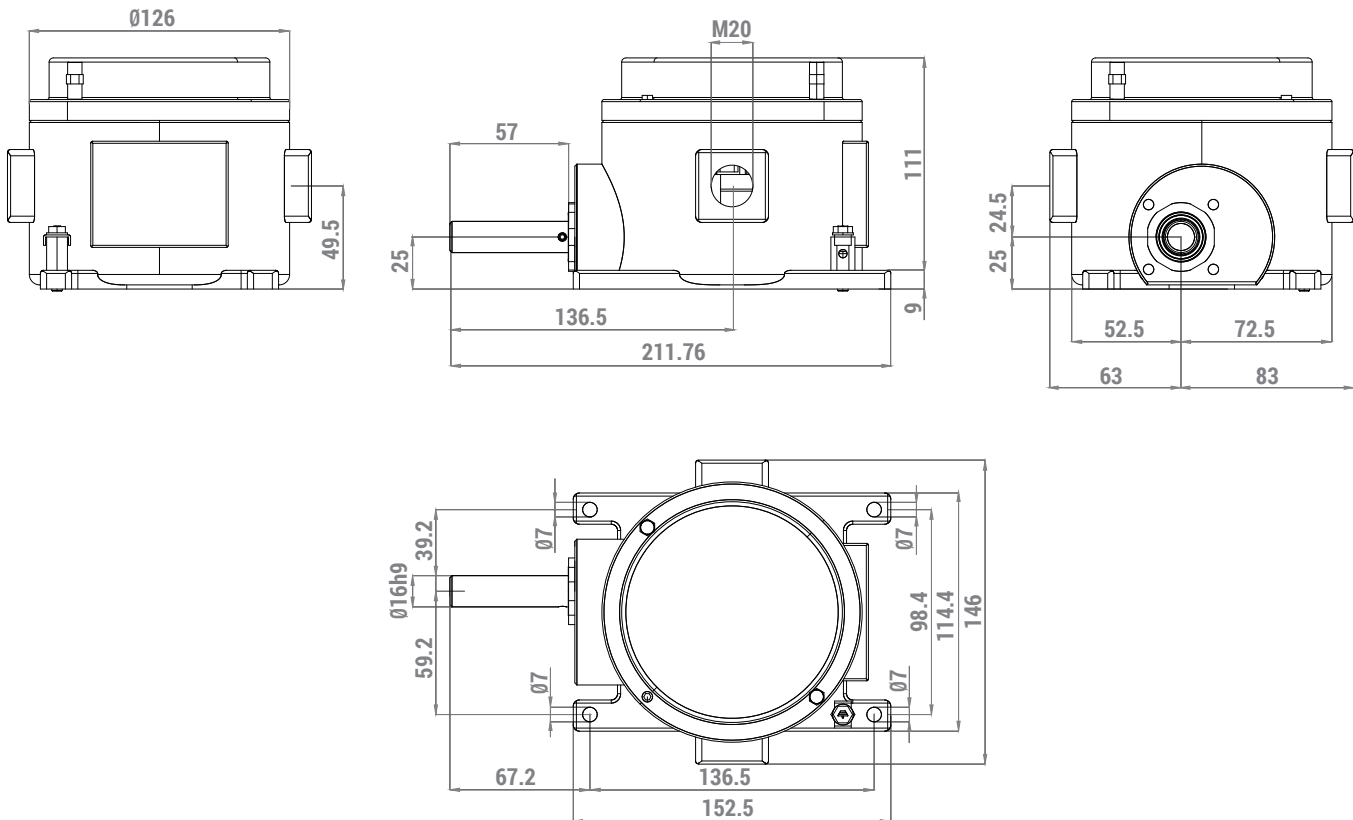

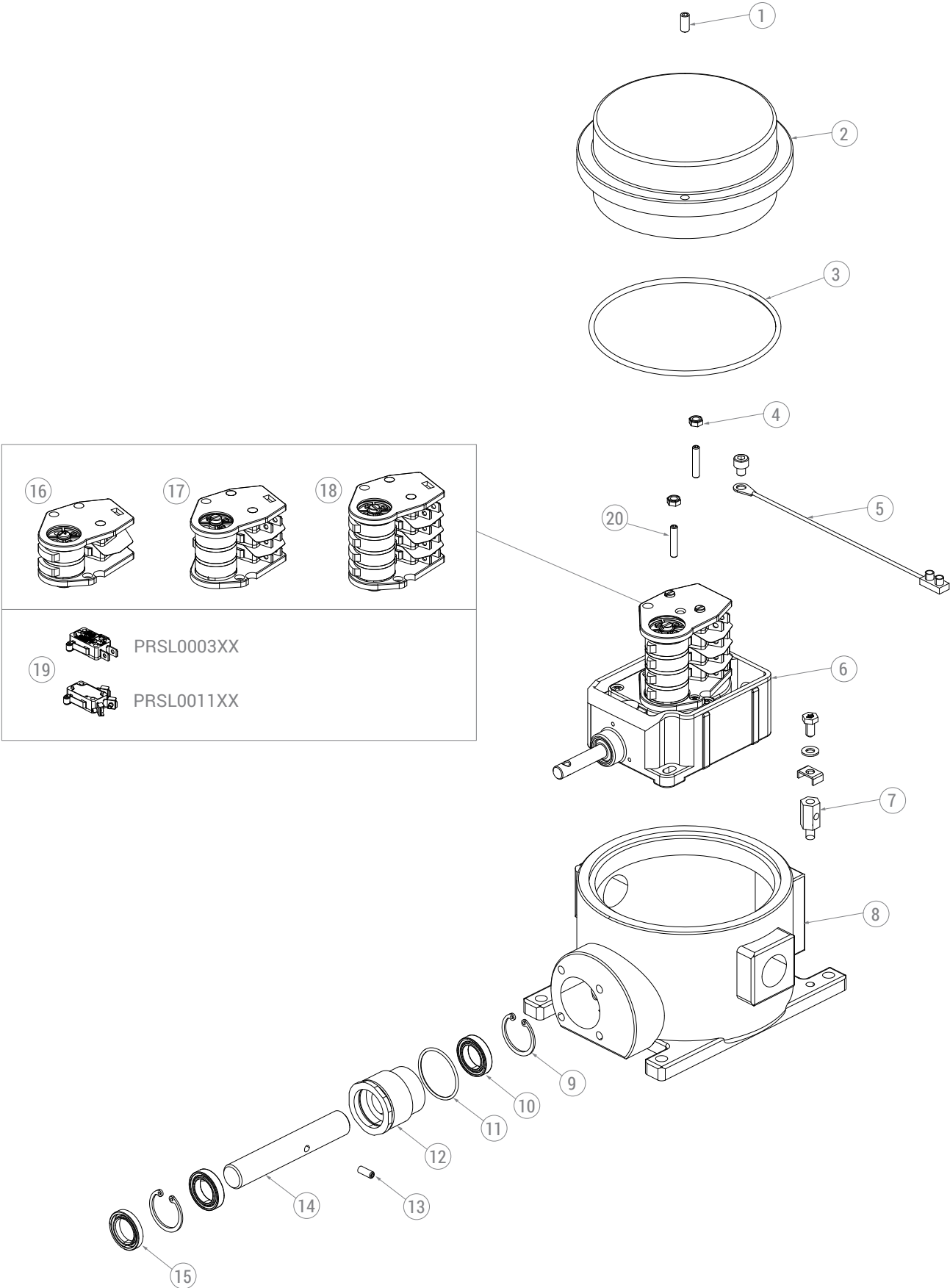

EXPLODED DRAWING







COMPONENTS

Standard cam sets

Ref.	Drawing	No. and type of cams	No. and type of switches	Code
16		2 cams A	2 PRSL0003XX switches	PRFC0008PEC
		2 cams C	2 PRSL0003XX switches	PRFC0009PEC
17		3 cams A	3 PRSL0003XX switches	PRFC0004PEC
		3 cams C	3 PRSL0003XX switches	PRFC0006PEC
18		4 cams A	4 PRSL0003XX switches	PRFC0202PEC
		4 cams C	4 PRSL0003XX switches	PRFC0198PEC

Other sets with 2/3 or 4 switches are available on request.

Cam reference chart

Cam			Switching angle	Code
A		1 point	20.5° ±0.5°	PRSL7140PI
B		10 points	14.0° ±0.5°	PRSL7142PI
C		60° sector	78.0° ±0.5°	PRSL7141PI
E		180° sector	199.5° ±0.5°	PRSL7144PI
H		335° sector	344.0° ±0.5°	PRSL7143PI

LIMITEX AG - REQUEST FORM FOR LIMIT SWITCH

Instructions

1 Standard cam set: write the code of the cam set required.

2 Customized cam set: for non standard cam sets, fill in the scheme choosing the cams and the switches required.
Customized cams are available on request.

3 Revolution ratio: write the required revolution ratio.

Standard cam set 1

Cam set code

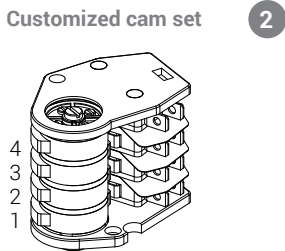

Cam code Switch code

4 _____ _____

3 _____ _____

2 _____ _____

1 _____ _____

Revolution ratio 3





<input type="checkbox"/> 1:15	<input type="checkbox"/> 1:75
<input type="checkbox"/> 1:20	<input type="checkbox"/> 1:100
<input type="checkbox"/> 1:25	<input type="checkbox"/> 1:150
<input type="checkbox"/> 1:50	<input type="checkbox"/> 1: <input style="width: 50px;" type="text"/>

Remarks

1 Legend - Standard cam sets

No. & type of switches	No. & type of cams	Code
2 x PRSL0003XX	2 cams A	PRFC0008PEC
	2 cams C	PRFC0009PEC
3 x PRSL0003XX	3 cams A	PRFC0004PEC
	3 cams C	PRFC0006PEC
4 x PRSL0003XX	4 cams A	PRFC0202PEC
	4 cams C	PRFC0198PEC

2 Legend - Standard cams

Cam		Switching angle	Code
A 	1 point	20,5° ±0,5°	PRSL7140PI
B 	10 points	14,0° ±0,5°	PRSL7142PI
C 	60° sector	78,0° ±0,5°	PRSL7141PI
E 	180° sector	199,5° ±0,5°	PRSL7144PI
H 	335° sector	344,0° ±0,5°	PRSL7143PI

Legend - Switches

PRSL0003XX	PRSL0011XX
1NO+1NC 	1NO+1NC 